

Whether you want to solve your ticket payout problems, reduce ticket overheads or add new feature to your games to boost earnings the Ticketflex Maximizer Boards provide simple and inexpensive solutions.

T
I
C
K
E
T
S

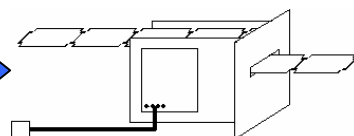

GET THE TICKET PAYOUT UNDER CONTROL



The Most Versatile Ticket Dispenser Controller Board on the Market.

C
O
I
N
S

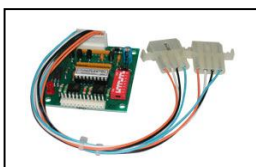

TICKETFLEX HOPPER CONTROLLERS

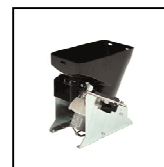

Make Your Own Change Machine or Add Token Output to any Game.

G
U
N
S



Revitalize your shooting games with RAPID FIRE



Rapid Fire for Shooting Games.

Ticketflex Maximizer Selector Table

Model No.	Name	Application (see legend)
TFB1	Ticketflex Maximizer - Standard	M, D, DT, ZT, TB, TE, TM, CO, PO, CI, PI
TFB1-TS	Ticketflex Maximizer - Ticket SAVER	D, ARQ, ARS, MT, TE, TM, CO, PO, CI, PI
TFB1-PB	Ticketflex Maximizer - External Bonus Control	M, D, DT, ZT, EB, TE, TM, CO, PO, CI, PI
TFB1-GO	Ticketflex Maximizer - with Game Over Control	M, D, DT, ZT, GO, TE, TM, CO, PO, CI, PI
TFB1-BS	Ticketflex Maximizer - Mercy Tickets	AMT, FT, ST, TE, TM, CO, PO, CI, PI
TFB3	Ticketflex Maximizer - with Skill Mode	MP, DP, SM, WL, TB, TE, TM, PI, CO
TFB1-AS	Ticketflex Hopper Controller for Asahi Seiko SH-400	Adjustable Pulse In/Coin Out or DL1275 mode
TFBHOP	Ticketflex Universal Hopper Controller	Adjustable Pulse In/Coin Out operation
TFG1	Ticketflex AutoGun Board	Rapid fire for ordinary guns

M Multiply
D Divide
DT Dispenser Test
ZT Zero Ticket Mode
TB Time Bonus Mode
TE Ticket Empty Indicator

TM Ticket Meter Output
CO Continuous Output (DL1275)
PO Pulse Output (DL4)
CI Continuous Input (DL1275)
PI Pulse Input (DL4)
ARQ Auto Round Up (quick drop games)

ARS Auto Round Up (Slow)
MT Mercy Ticket input
EB External Bonus Control
GO Game Over Input (disable tck)
AMT Adjustable Mercy Tickets
FT Fast Trigger

DT Slow Trigger
MP Multiply Payout
DP Divide Payout
SM Skill Mode
WL Winner Level

TicketFLEX™

Innovation Search

Ticketflex Maximizer – Standard **Model: TFB1**

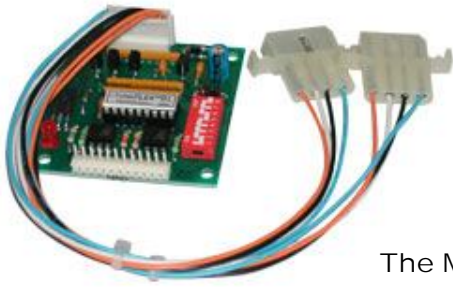

Download Instruction Sheet
www.ticketflex.com/Support.htm

BUY On-line at
www.ticketflex.com

GET TICKET PAYOUT
 UNDER CONTROL

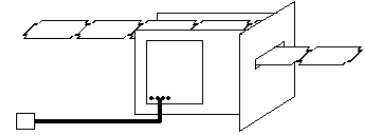

The Most Versatile Ticket Dispenser Controller Board on the Market.

1

Model: TFB1

ADJUST TICKET PAYOUT in your ticket redemption machines.

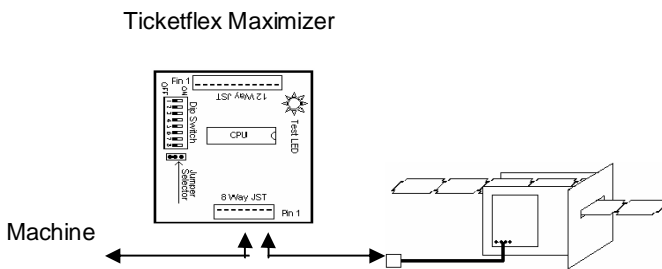

- Instant, Plug-In Solution, comes with harness for the Deltronic 1275 or the Entropy ticket dispenser.
- Adjust the ticket payout the way you need
- Large range of settings available via dip switch to increase or decrease the payout

This board will let you use the Deltronic 1275 instead of the Deltronic DL4 dispenser or the other way around.

2

Model: TFB1

BOOST EARNINGS WITH THE DOUBLE TICKET TIME BONUS.

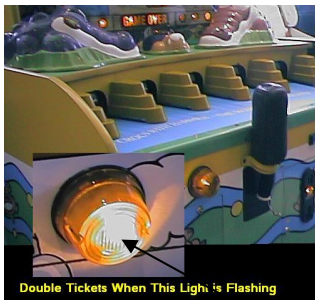

MAKE YOUR GAMES MORE EXCITING FOR THE PLAYERS

An excellent feature, designed to provide an additional incentive for the player to start a game. The Ticketflex Maximizer controls an external lamp. While this lamp is flashing the player will receive more tickets than what the game normally gives; actually twice the normal amount. The lamp flashes for a duration of 1 minute and starts automatically flashing every 5 minutes. The flashing light also brightens up your game and draws the player's attention. Simple signage such as "DOUBLE TICKETS WHEN THIS LIGHT IS FLASHING" is enough for the player to understand the system. All you need to do is to connect one external lamp and flick the dip switch to enable it.

3

Model: TFB1

ADD TICKET FEATURE TO YOUR VIDEO GAMES.



WHY NOT HAVE TICKETS ON VIDEO GAMES? Kids love it!

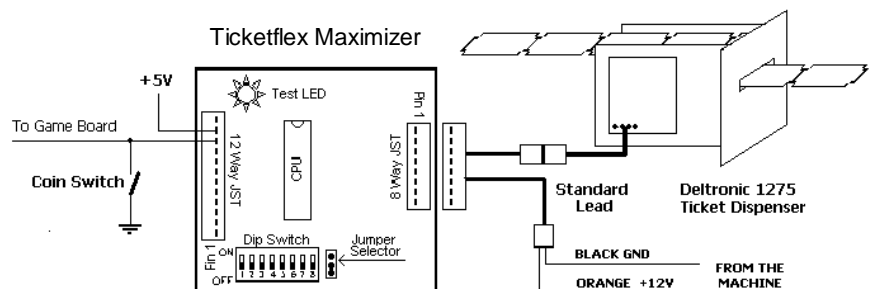

Simple upgrade, coin switch/credit pulse or coin meter pulse triggers tickets. The payout is fully adjustable and can be combined with the TIME BONUS feature.

4

Model: TFB1

ADD TICKET FEATURE TO YOUR PINBALL MACHINES.

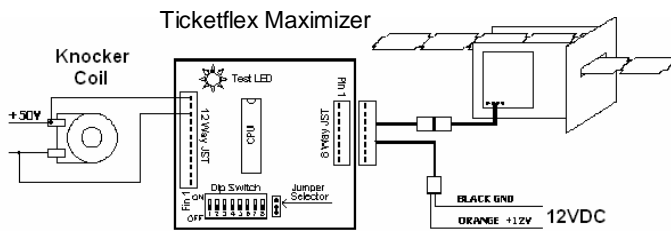

Adding ticket feature to a pinball machine was never easier. Connect the Kicker Coil and 12V to the Maximizer and the job is DONE! No other special ticket interface board is required. You can set 1 to 15 tickets per REPLAY. You can enable the TIME BONUS to make your game even more exciting!



5

Model: TFB1

OPERATION WITHOUT TICKETS.

In some situations it is desirable to operate a machine without tickets (Show Rooms, Special Parties, Games Hire, Home Operation etc.) However, this is not often possible because the machine will detect an ERROR if the ticket dispenser is disconnected. The Maximizer solves this problem. Set the dipswitch to ZERO TICKET MODE!

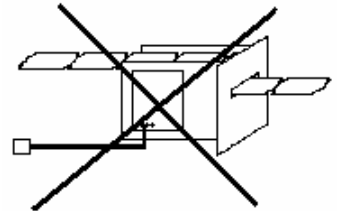
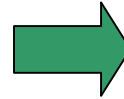
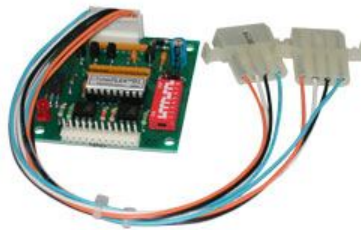

6

Model: TFB1

HANDY TOOL FOR OPERATORS AND TECHNICIANS.

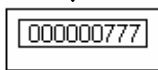
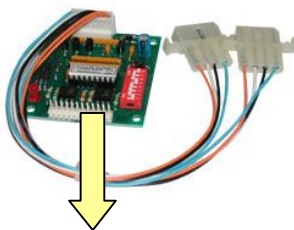

Ticket Meter

Often tickets are wasted during the servicing of the machine (testing and the ticket payout adjustments). The Ticketflex Maximizer can be a handy addition to your tool box. All you need to do is to connect a TICKET METER and you are ready to plug in the Maximizer instead of the ticket dispenser. You can play the game and test the payout without wasting a single ticket. The meter will show you the number of tickets the machine tried to dispense.

Set Dip Switches to:

1=OFF, 2,3,4=ON, 5=OFF, 6=ON, 8=ON

7= ON for Deltronic 1275 compatible dispensers (with notch feedback)

7=OFF Deltronic DL-4 compatible dispensers (pulse operation)

7

Model: TFB1

BUILT IN TICKET DISPENSER TEST.

Not sure if the Ticket Dispenser is faulty? Or is something else wrong with the machine?

The Maximizer will test your dispenser and give you the answer in a few seconds. All you need to do is to set the Dip Switch for the Test Mode and turn ON the machine.

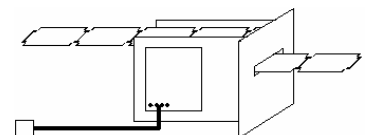

OTHER FEATURES:

- Supplied with Harness which fits Happ, Deltronic or Entropy Ticket dispenser
- Drives almost any ticket dispenser
- Output for a Ticket Meter
- Lamp output to indicate "Ticket Jam Error" or "Empty Tickets"
- Direct and Opto-Isolated inputs for easy interfacing to any machine
- Small size 2.5" x 2.5", fits everywhere



Download Instruction Sheet
www.ticketflex.com/Support.htm

BUY On-line at
www.ticketflex.com

REDUCE TICKET OVERHEADS – SAVE THOUSANDS!

The Ticketflex Ticket Saver is specifically designed to do this job quickly and inexpensively. You can set the dip switch for the desired saving. The example below shows what you **NEED TO DO** and what **YOU DON'T NEED TO DO** if you choose to achieve 80% saving on the ticket overheads.

THREE SIMPLE STEPS TO ACHIEVE 80% SAVING

1

Set the dip switch on the Ticket Saver for Divide by 5.

2

Plug-in the Ticket Saver (Harness for Deltronic 1275 or Entropy dispenser supplied).

3

Get each ticket printed with **POWER TICKET - WORTH 5 TICKETS**

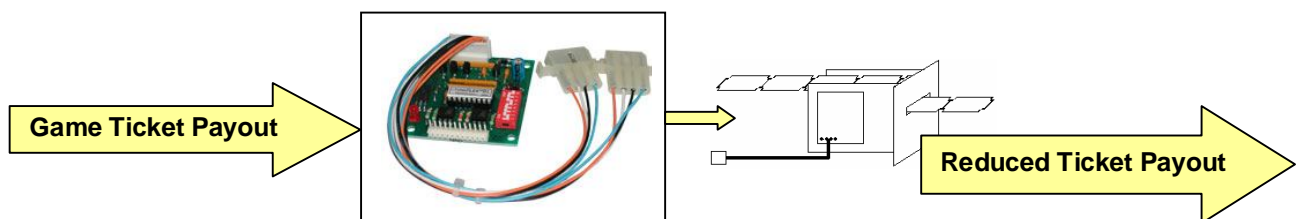

Reduce the number of tickets dispensed without touching the game settings.

WHAT YOU DON'T NEED TO DO

1. **NO NEED** to re-label the machines (the score cards stay the same)
2. **NO NEED** to touch the game settings
3. **NO NEED** to change the ticket value of your prizes

Dividing the ticket payout by factor of 5 in the above example represents 80% saving on the ticket cost. If the game would normally dispense 20 tickets the players will get 4 tickets only but each of them would have the value of 5 tickets (the player receives the same value of 20 tickets as each ticket can be printed with "**POWER TICKET - WORTH 5 TICKETS**").

THE AUTOMATIC ROUND UP

In case that the game would normally dispense 18 tickets instead of 20, the Ticket SAVER will dispense still 4 tickets as the ROUND UP feature will automatically handle this shortfall to compensate the player. The player will always be happy. There are two different settings for the automatic round up feature to suit different styles of ticket redemption games.

COIN TRIGGERED MERCY TICKET

The connection of this input is optional. If desired it can be hooked up to get a Mercy Ticket triggered by coin pulse.

Designed to suit various styles of redemption games and various types of ticket dispensers.

Model: TFB1-PB

EXTERNALLY OPERATED DOUBLE TICKET BONUS

Download Instruction Sheet
www.ticketflex.com/Support.htm

BUY On-line at
www.ticketflex.com

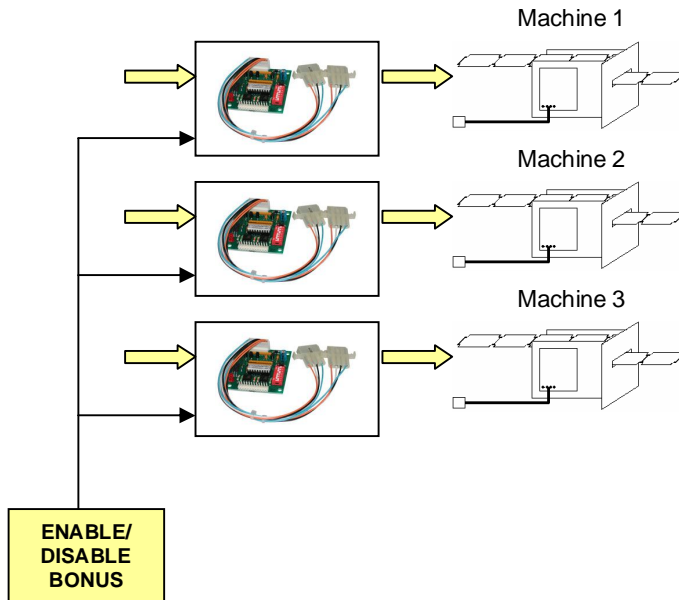

WIN
DOUBLE
AMOUNT OF
TICKETS WHEN
THIS LIGHT IS
FLASHING!



The Ticketflex Maximizer MODEL TFB1-PB enables you to TURN ON the Double Ticket Bonus Externally. One external switch can control several machines. The BONUS mode stays ON as long as the switch is turned ON.

WHY NOT TO TURN THE BONUS MODE ON in times you want to increase the traffic in your center.

You can at the same time use the Multiplier or Divider Mode to control the ticket payout.

Or use this board for HAPPY HOUR - Two Games for the Price of One



Imagine offering your players a Happy Hour any time you like. The machines in your center would instantly change to "TWO GAMES FOR THE PRICE OF ONE" just by flicking a single switch.

This can be realized by the Ticketflex Maximizer TFB1-PB connected between the coin mech and the game board credit input. The machines can be linked up with a simple two wire cable allowing one external switch to control multiple machines. Alternatively you could control the date, the time and the duration of the Happy Hour automatically by an external timer (the timer is not supplied).

This board can operate an external light, which will be flashing while the bonus mode is turned ON.

Model: TFB1-BS

ADJUSTABLE MERCY TICKETS

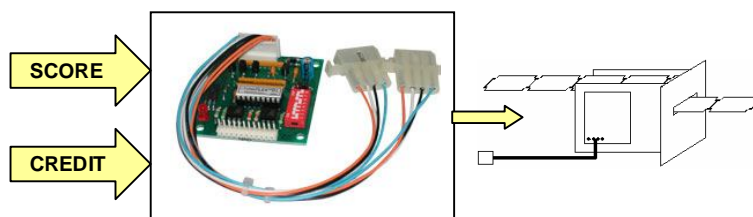

With the Ticketflex Maximizer MODEL TFB1-BS the Mercy Ticket feature can be added to any existing ticket redemption game.

In addition to the tickets dispensed per the game score, the players will receive Mercy Tickets for every paid credit.

Quick and simple installation. Adjust 1 to 15 Mercy Tickets via the Dip Switch.

Model: TFB1-GO

TICKETFLEX MAXIMIZER WITH GAME OVER CONTROL

Download Instruction Sheet
www.ticketflex.com/Support.htm

BUY On-line at
www.ticketflex.com

TURN THE TICKETS OFF WHEN THEY ARE NOT DESIRABLE - FOR SHOWROOMS, TRADE SHOWS, BIRTHDAY PARTIES, SPECIAL SESSIONS

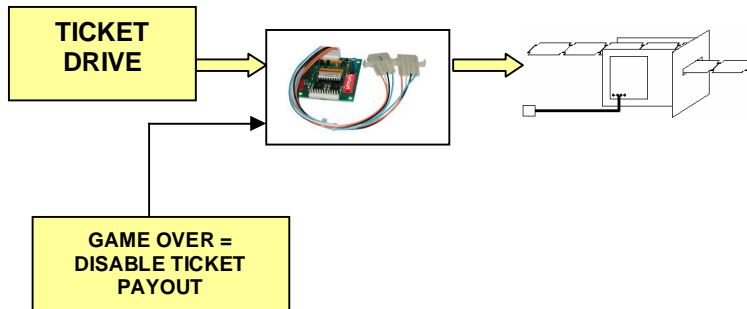

This handy board has an opto isolated Game Over Input (ticket disable) via which, the ticket output can be disabled without causing the game to go to a Ticket Error. The board will simulate ticket notches for the game while the payout is disabled. This can be useful for birthday parties, special sessions, showrooms, trade shows etc. where tickets are not desirable.

The board has the full functionality of the Divide / Multiply mode via which the ticket payout can be adjusted.

RESTORE YOUR OLD TICKET REDEMPTION GAMES.

Many old games have been designed such a way that the ticket payout is not any more suitable for today's conditions or they work unreliably. This Ticketflex Maximizer can help you to replace the original ticket payout system.

All you may need is to set this board for the PULSE INPUT operation (Dip Sw 7 = OFF) and connect a switch to trigger the ticket payout (e.g. the score switch in Basket Ball games, Skee Ball type of games etc.). You can utilize the "Game Over" signal (or the coin lockout) from the machine to Enable or Disable the ticket payout by connecting it to the Game Over input of the Ticketflex Maximizer. The dipswitch settings provide wide range of settings to suit your needs.

Model: TFB3

TICKETFLEX MAXIMIZER WITH SKILL MODE

Download Instruction Sheet
www.ticketflex.com/Support.htm

BUY On-line at
www.ticketflex.com



DESIGNED TO INSTALL A TICKET OUTPUT TO ANY COIN-OP MACHINE.

This board has a unique SKILL MODE feature, which simulates ticket payout according to the skill of the player. In this mode the tickets are dispensed during the game. More skilful players achieve longer game times and will be rewarded by more tickets.

For games where the Skill Mode is not suitable this board can also operate in the simpler Divider/ Multiplier mode where the ticket(s) are dispensed per credit at the start of the game.

Very flexible adjustments will allow to optimise the ticket payout to suit your needs.

For Video Games. Pinball Machines. Kiddie Rides, Juke Boxes, any coin-op machine.

Model: TFB1-AS

TICKETFLEX HOPPER CONTROLLER

Download Instruction Sheet
www.ticketflex.com/Support.htm

BUY On-line at
www.ticketflex.com

For Asahi Seiko SH-400 Hopper.

This board offers simple and inexpensive solution for driving the low cost Asahi Seiko SH-400 or compatible hopper. It can work in two different modes.

PULSE IN / COIN OUT OPERATION

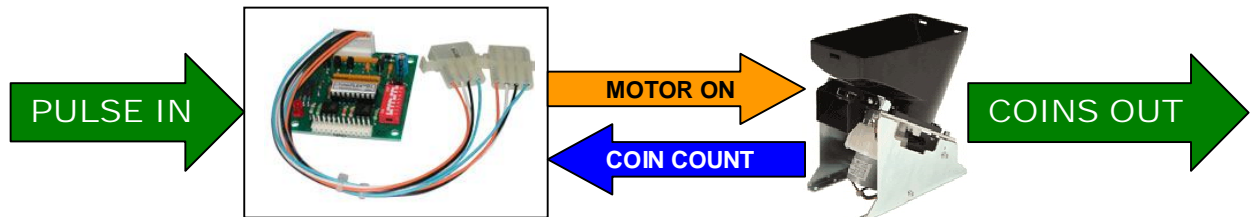

This mode will allow you to add coin or token output to any arcade game or create your own change machine. A pulse coming from a switch, coin acceptor, note acceptor etc. will initiate coin/token payout. An opto-isolated input is also available for a flexible interfacing with variety of machines. This input can be connected directly across DC coils, lamps etc. and the pulse(s) intercepted for triggering the coin/token payout.

DELTRONIC 1275 OPERATION

In this mode this board will allow you to run a coin/ token hopper instead of the Deltronic or Entropy ticket dispenser. Add new excitement to your ticket redemption games by converting Ticket Output to a Token output.

Flexible dip switch settings to achieve desired payout.

Model: TFBHOP

TICKETFLEX UNIVERSAL HOPPER CONTROLLER

Universal Hopper Controller Board with flexible Coin/Tokens setting. The dip switch can be set that 1 Pulse on the input will produce 1,2,3,4....up to 15 coins/tokens or it can work the other way around, where 1 coin/token is dispensed for 1,2,3,4.up to 15 pulses applied to the input.

The Model TFBHOP drives Universal Hoppers such the MK2 from Coin Controls (now Money Controls).

Can be supplied with custom dip switch settings on the request to suit your application.

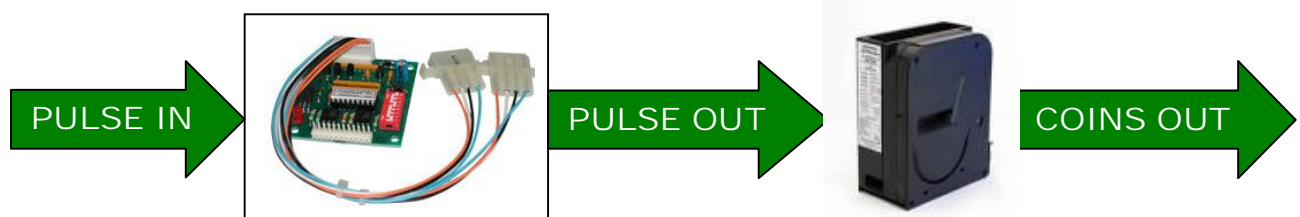

Model: TFG1

TICKETFLEX AUTO GUN BOARD

Download Instruction Sheet
www.ticketflex.com/Support.htm

BUY On-line at
www.ticketflex.com

RAPID FIRE

AN EXCELLENT UPGRADE FOR THE OLDER GUN GAMES

The Ticketflex Auto Gun Board turns an ordinary gun into a machine gun and gives the players a new level of fun and excitement. Your players will play like the experts and enjoy the game like never before. The ticketflex Auto Gun Board connects to the gun cable via the two 4 way Molex plugs.

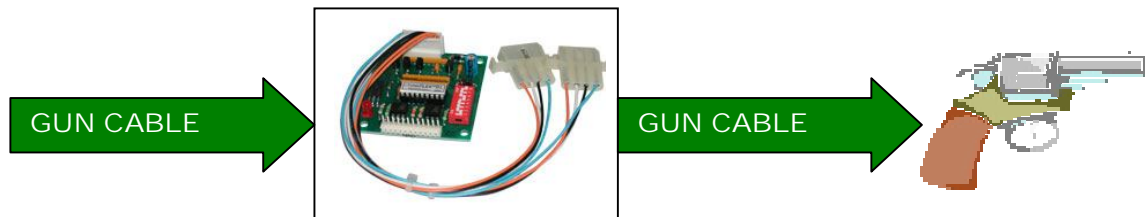

There is also a kit available for the Sega House of Dead 2 or The Lost World. Part No: TFG1KIT-INFRA. For more information visit www.ticketflex.com.

LET US KNOW WHAT YOU REQUIRE

The Ticketflex Maximizer boards can be tailored to your needs. We can supply customized programs for these boards which will change the functionality or the ticket payout settings to suit your operation. All we need to know is what you require.

TicketFLEX™
Innovation Search

WEBSITE: www.ticketflex.com
EMAIL: info@ticketflex.com

PHONE: +612 9665 7158
FAX: +612 9315 8681

MAIL: Ticketflex Pty.Ltd.
PO Box 622
Randwick NSW 2031
Sydney, Australia